

Det 3. Bracket Modul Solar Cell  
SCALE 1 : 25

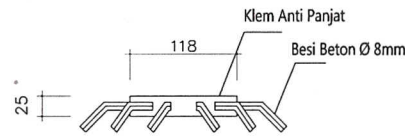

Det 2. Klem Anti Panjat  
SCALE 1 : 25

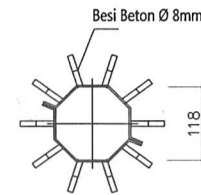

Det 2. Klem Anti Panjat  
SCALE 1 : 25

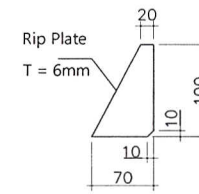

Det. Rip Plate  
SCALE 1 : 25

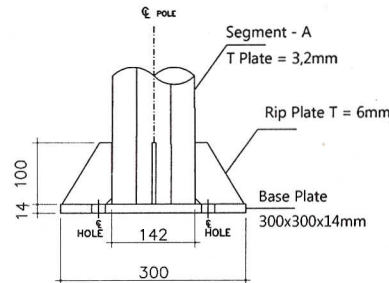
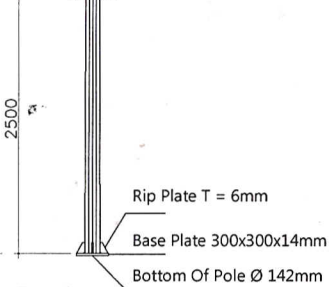

Det 1. Base Plate  
SCALE 1 : 25

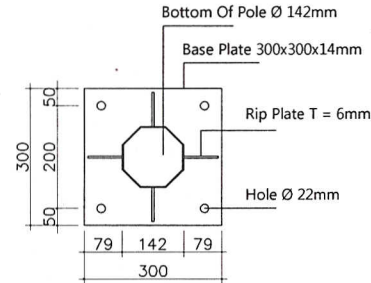

Det 1. Base Plate  
SCALE 1 : 25

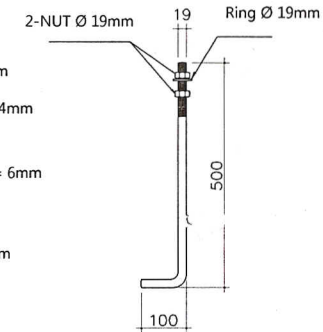

Det. Anchor Bolt  
SCALE 1 : 25

TIANG PJU H-09M DT TYPE SC  
SCALE 1 : 100

OCTAGONAL

KETERANGAN

STANDART MUTU :

- ISO 9001 : 2008
- Plate Baja : ST 41 / SS 400
- Welding : Las Listrik
- Finishing Hot Dip Galvanize
- Segment System Slip Joint
- Segment A = 6000mm
- Segment B = 3300mm
- Bottom Of Pole Ø 142mm
- Base Plate 300x300x14mm

PRODUCTION :

JOB TITLE :

TECHNICAL SPECIFICATION

CLIENT :

TOTAL :

DRAWING TITLE :

TIANG PJU OCTAGONAL  
H-09M DOUBLE T

DATE	CLIENT APPROVAL	APPROVAL
CAD	DESIGN	CHECK
Auto CAD 2009	Dwi. Y	Efi